

# VOSS



[www.voss-fluid.net](http://www.voss-fluid.net)

VOSS Ring<sup>M</sup>  
cutting ring couplings



2SVA  
cutting ring couplings



ES-4 / ES-4VA  
cutting ring couplings



VOSSForm<sup>SQR</sup> / VOSSForm<sup>SQRVA</sup>  
tube couplings



BV-10  
flared couplings



Adjustable couplings as per  
ISO 6149 / 11926

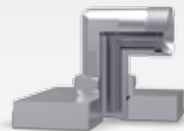

Taper couplings (DKO)



Adjustable elbow couplings  
with lock nut

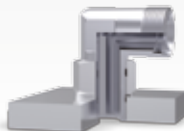

ZAKO / ZAKO LP  
flange couplings



37° flared adapters



Straight male stud couplings



Blanking screws



Type 80 N3

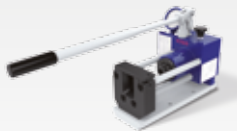

Ideal for the following systems:

- VOSS Ring<sup>M</sup>
- 2SVA
- ES-4
- BV-10
- ZAKO (Tube-OD S16–S38)

Type 90 Basic II



Ideal for the following systems:

- VOSS Ring<sup>M</sup>
- 2SVA
- ES-4
- ES-4VA
- BV-10
- ZAKO (Tube-OD S16–S38)

Type 90 Comfort



Ideal for the following systems:

- VOSS Ring<sup>M</sup>
- 2SVA
- ES-4
- ES-4VA
- BV-10
- ZAKO (Tube-OD S16–S38)

Type 85



Ideal for the following systems:

- ZAKO / ZAKO LP

VOSSForm 100



Ideal for the following systems:

- VOSSForm<sup>SQR</sup>
- VOSSForm<sup>SQR</sup> VA

VOSSForm 100 Compact

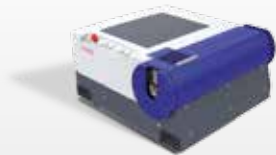

Ideal for the following systems:

- VOSSForm<sup>SQR</sup>
- VOSSForm<sup>SQR</sup> VA

## Important notes on VOSS assembly instructions

In order to ensure maximum performance and functional reliability of VOSS products, the respective assembly instructions, operating conditions and tube recommendations have to be adhered to.

We always recommend the use of VOSS pre-assembly devices and this is strongly recommended starting from tube sizes L18 / S16. It is absolutely essential to follow the operating instructions for the respective pre-assembly device used.

Do not start with assembly until you are absolutely sure that you have understood the operating and assembly instructions for each VOSS pre-assembly device or machine, tool and product. Incorrect handling leads to risks regarding safety and leak-tightness and can result in failure of the entire connection.

It is impossible for the manufacturer to monitor whether the user is adhering to the operating and assembly instructions for individual pre-assembly devices or machines, tools and products, as well as what conditions prevail and what methods are used for installation, operation, application and maintenance of the individual products. Improper workmanship can lead to material damage, which in turn may pose a danger to life and limb. This means that VOSS Fluid GmbH can accept no responsibility or liability for loss, damage or costs incurred due to faulty installation, improper operation or incorrect application and maintenance or from any related issue. Failure to heed this warning will lead to loss of guarantee.

VOSS Fluid GmbH reserves the right to make changes or additions to the information provided without prior notification. Customers can obtain the latest version of the operating and assembly instructions upon request, or from our download area at: [www.voss-fluid.net](http://www.voss-fluid.net)

## General notes on VOSS assembly instructions

Make sure that all components, including the tubes, are clean before assembly is started and that they remain clean during the entire assembly process. Soiled components may lead to failure of the system. Before starting assembly, make sure that you have carried out all preparatory work in accordance with the respective instructions.

### Specifications concerning permissible steel tubes:

seamless, cold-drawn and normalized precision steel tubes as specified in DIN EN 10305-4, material E235+N, mat. no. 1.0308+N or E355, mat. no. 1.0580. The tubes must be ordered by specifying the outer diameter and the inner diameter.

### Specifications concerning permissible stainless steel tubes:

seamless, cold-drawn and solution-annealed, scale-free stainless steel tubes in CFA or CFD delivery condition of dimensions and tolerances according to DIN EN 10305-1 and all other delivery conditions as specified in DIN EN 10216-5, material X6CrNiMoTi17-12-2, mat. no. 1.4571. The tubes must be ordered by specifying the outer diameter and the inner diameter.

The tubes should be prepared with the same thoroughness as pre-assembly and final assembly of the connection. Especially when using long tubes, check the end sections for damage or distortion. We recommend that pre-assembled tubes which are not to be finally assembled yet should be fitted with protective caps.

Marking a stroke on the union nut and the tube makes it easier to achieve the correct number of turns when tightening the coupling.

Before starting to assemble VOSS components with elastomer seals, always check that:

- the nut and the seal surfaces are clean and undamaged and / or
- the elastomer sealing is clean and undamaged

### Determining the tightening torque for screw couplings

The included tightening torques apply under the following conditions:

- Steel couplings with VOSS coat surface coating
- The recommended tightening torques refer to steel threads with VOSS coat surface finish and a steel mating material with a breaking stress of 350 N/mm<sup>2</sup>. Steel threads with increased pressure level require a mating material with a breaking stress of  $\geq 600$  N/mm<sup>2</sup>.
- our recommendations on lubrication of the threaded studs are observed

If other values for strength, modulus of elasticity and friction-surface combinations are used, the user has to adapt the tightening torque empirically. The recommended tightening torques have to be adhered to if the pressure range is to be fully utilized and the appropriate safety level is to be maintained. The recommended tightening torques for the threads are given in the tables for the respective type of thread.

VOSS Ring<sup>M</sup>

2SVA

ES-4 / ES-4VA

VOSSForm<sup>SQR</sup> /  
VOSSForm<sup>SQR</sup> VA

BV-10

DKO

ZAKO / ZAKO LP

Straight male  
stud couplingsAdjustable ISO 6149 /  
11926 couplingsAdjustable  
elbow couplings

37° flared adapters

Blanking screws

Pressure setting values for VOSS *Ring*<sup>M</sup> cutting ring couplings



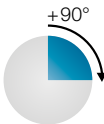
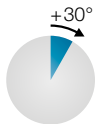

Series / Tube	Before final assembly, tighten the union nut until you notice an clearly force increase		Pressure setting values Type 80 N2 / N3				Pressure setting values Type 90 Basic II				Pressure setting values Type 90 Comfort			
	mm	Universal pre- assembly stud	VOSSRing <sup>M</sup> pre-assembly stud		VOSSRing <sup>M</sup> pre-assembly stud		VOSSRing <sup>M</sup> pre-assembly stud		VOSSRing <sup>M</sup> pre-assembly stud		VOSSRing <sup>M</sup> pre-assembly stud		VOSSRing <sup>M</sup> pre-assembly stud	
			ST ~ bar	SST ~ bar	ST ~ bar	SST ~ bar	ST ~ bar	SST ~ bar	ST ~ bar	SST ~ bar	ST ~ bar	SST ~ bar	ST ~ bar	SST ~ bar
L/S 6	 		100	120	100	120	26	32	28	34				
L/S 8			110	130	110	130	28	35	30	37				
L/S10			150	170	150	180	36	40	38	46				
L/S12			170	195	170	200	40	45	44	53				
S 14			190	205	200	240	45	50	52	62				
L 15			170	210	190	230	43	52	50	60				
S 16			205	240	230	280	50	60	60	72				
L 18			200	215	230	280	48	55	60	72				
S 20			240	305	310	370	60	75	80	96				
L 22			260	285	290	350	61	72	75	90				
S 25			320	380	360	430	80	95	92	110				
L 28			300	350	350	420	75	88	90	108				
S 30			430	530	520	600	105	135	135	162				
L 35			410	570	500	600	101	139	130	156				
S 38		600	–	600	–	150	180	170	200					
L 42		490	–	600	–	123	155	170	200					

RFID  
Settings  
stored in the machine

Pressure setting values for 2SVA cutting ring couplings



Important / General information

VOSS Ring<sup>M</sup>

2SVA

ES-4 / ES-4VA

VOSSForm<sup>SQR</sup> /  
VOSSForm<sup>SQR</sup> VA

BV-10

DKO

ZAKO / ZAKO LP





Straight male  
stud couplings

Adjustable ISO 6149 /  
11926 couplings

Adjustable  
elbow couplings

37° flared adapters

Blanking screws

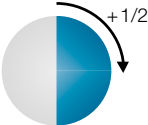
				
Series / Tube	Before final assembly, tighten the union nut until you notice an clearly force increase	Pressure setting values Type 80 N2 / N3	Pressure setting values Type 90 Basic II	Pressure setting values Type 90 Comfort
mm	Universal pre-assembly stud	Universal pre-assembly stud 2SVA SST ~ bar	Universal pre-assembly stud 2SVA SST ~ bar	Universal pre-assembly stud 2SVA SST ~ bar
L/S 6		120	32	RFID Settings stored in the machine
L/S 8		130	35	
L/S10		170	40	
L/S12		195	45	
S 14		205	50	
L 15		210	52	
S 16		240	60	
L 18		215	55	
S 20		305	75	
L 22		285	72	
S 25		380	95	
L 28		350	88	
S 30		530	135	
L 35		570	139	
S 38		-	180	
L 42	-	155		

Pressure setting values for ES-4/ES-4VA cutting ring couplings



Important / General information

VOSS Ring<sup>M</sup>

2SVA

ES-4 / ES-4VA

VOSSForm<sup>SQR</sup> /  
VOSSForm<sup>SQR</sup> VA

BV-10

DKO

ZAKO / ZAKO LP

Straight male  
stud couplings

Adjustable ISO 6149 /  
11926 couplings

Adjustable  
elbow couplings

37° flared adapters

Blanking screws

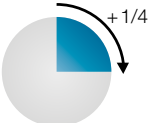
Series / Tube	Before final assembly, tighten the union nut until you notice a clearly force increase	Pressure setting values Type 80 N2 / N3		Pressure setting values Type 90 Basic II		Pressure setting values Type 90 Comfort	
mm	Universal pre-assembly stud	Universal pre-assembly stud		Universal pre-assembly stud		Universal pre-assembly stud	
		ES-4 ST ~ bar	ES-4VA SST ~ bar	ES-4 ST ~ bar	ES-4VA SST ~ bar	ES-4 ST ~ bar	ES-4VA SST ~ bar
L/S 6		100	120	26	32	RFID Settings stored in the machine	
L/S 8		110	130	28	35		
L/S10		150	170	36	40		
L/S12		170	195	40	45		
S 14		190	205	45	50		
L 15		170	210	43	52		
S 16		205	240	50	60		
L 18		200	215	48	55		
S 20		240	305	60	75		
L 22		260	285	61	72		
S 25		320	380	80	95		
L 28		300	350	75	88		
S 30		430	530	105	135		
L 35		410	570	101	139		
S 38		600	–	150	180		
L 42	490	–	123	155			

Tightening torques for VOSSForm<sup>SQR</sup> / VOSSForm<sup>SQR</sup> VA tube couplings

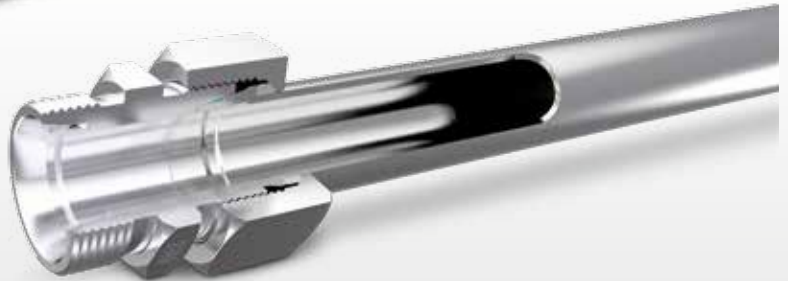

As an alternative to achieving pre-assembly and final assembly states by distance dependent assembly, the tightening torques can be applied directly.

The stated tightening torques are guideline values which have been determined under the following conditions:

- Tube specifications as given in the general notes.
- Surface coating of the coupling components is VOSS coat. The SQR function nut is additionally waxed.

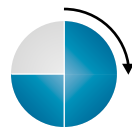

Series	Tube OD [mm]	Before final assembly of the SQR function nut, hand tighten	Tightening torque Nm $\pm$ 5 %	
			ST	SST
L	6	approx. 1/2–3/4 turns 	20	25
L	8		30	35
L	10		40	55
L	12		50	65
L	15		70	90
L	18		90	125
L	22		120	150
L	28		160	220
L	35		250	380
L	42		380	580
S	6		25	30
S	8		40	50
S	10	50	65	
S	12	60	85	
S	14	75	115	
S	16	85	125	
S	20	140	220	
S	25	190	300	
S	30	270	430	
S	38	400	640	

Important / General information

VOSS Ring<sup>M</sup>

2SVA

ES-4 / ES-4VA

VOSSForm<sup>SQR</sup> /  
VOSSForm<sup>SQR</sup> VA

BV-10

DKO

ZAKO / ZAKO LP

Straight male stud couplings

Adjustable ISO 6149 / 11926 couplings

Adjustable elbow couplings

37° flared adapters

Blanking screws

Final assembly for BV-10 flared couplings





Important / General information

VOSS Ring<sup>M</sup>

2SVA

ES-4 / ES-4VA

VOSSForm<sup>SQR</sup> /  
VOSSForm<sup>SQR</sup> VA

BV-10

DKO

ZAKO / ZAKO LP

Straight male  
stud couplings

Adjustable ISO 6149 /  
11926 couplings

Adjustable  
elbow couplings

37° flared adapters

Blanking screws

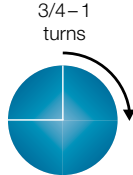

Series	Tube OD [mm]	Gap	Before final assembly of the union nut, hand tighten
L	6	≥ 0.5 to max. 1 mm	
L	8		
L	10		
L	12		
L	15		
L	18		
L	22		
L	28		
L	35		
L	42		
S	8		
S	10		
S	12		
S	14		
S	16		
S	20		
S	25		
S	30		
S	38		

## Tightening torque for taper couplings (DKO)

Tightening values not for hose fittings with DKO

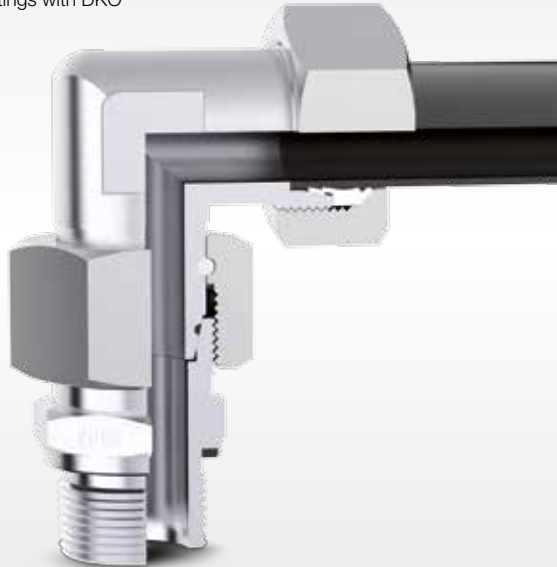

Important / General information

VOSS Ring<sup>M</sup>

2SVA

ES-4 / ES-4VA

VOSSForm<sup>SQR</sup> /  
VOSSForm<sup>SQR</sup> VA

BV-10

DKO

ZAKO / ZAKO LP

Straight male  
stud couplings

Adjustable ISO 6149 /  
11926 couplings

Adjustable  
elbow couplings

37° flared adapters

Blanking screws



Series	Tube OD [mm]	Threads of the union nut	Tighten union nut “manually” + value “X” turns		Tightening torque Nm ± 5 %
			Distance-depend-ent initial assembly turns	Distance-depend-ent repeat assembly turns	
L	6	M 12 x 1.5	approx. 2/3	approx. 1/3	20
L	8	M 14 x 1.5	approx. 2/3	approx. 1/3	30
L	10	M 16 x 1.5	approx. 2/3	approx. 1/3	40
L	12	M 18 x 1.5	approx. 2/3	approx. 1/3	50
L	15	M 22 x 1.5	approx. 2/3	approx. 1/3	70
L	18	M 26 x 1.5	approx. 1/2	approx. 1/3	90
L	22	M 30 x 2.0	approx. 1/2	approx. 1/3	120
L	28	M 36 x 2.0	approx. 1/3	approx. 1/3	160
L	35	M 45 x 2.0	approx. 1/3	approx. 1/3	250
L	42	M 52 x 2.0	approx. 1/3	approx. 1/4	380
S	6	M 14 x 1.5	approx. 2/3	approx. 1/3	25
S	8	M 16 x 1.5	approx. 2/3	approx. 1/3	40
S	10	M 18 x 1.5	approx. 2/3	approx. 1/3	50
S	12	M 20 x 1.5	approx. 2/3	approx. 1/3	60
S	16	M 24 x 1.5	approx. 1/2	approx. 1/3	85
S	20	M 30 x 2.0	approx. 1/2	approx. 1/3	140
S	25	M 36 x 2.0	approx. 1/3	approx. 1/4	190
S	30	M 42 x 2.0	approx. 1/3	approx. 1/4	270
S	38	M 52 x 2.0	approx. 1/3	approx. 1/4	400

Tightening torque for ZAKO / ZAKO LP flange couplings



Dimensions	Tightening torque for screws 10.9 (Nm max.)*
<b>ZAKO</b>	
M 8	35
M 10	69
M 12	120
M 14	190
M 16	295
M 20	580
M 24	800
M 30	1.500

Dimensions	Tightening torque for screws 8.8 (Nm max.)*
<b>ZAKO LP</b>	
M 8	14
M 10	28
M 12	49
M 16	135
M 20	275

### Caution!

When tightening the screws, never exceed the permissible tightening torques (see table)!

Tube wall thickness ZAKO	Gap width
8 mm < 16 mm	max. 3 mm
16 mm	max. 5 mm

Tube wall thickness ZAKO LP	Gap width
< 8 mm	≥ 1 to 1.5 mm

Important / General information

VOSS Ring<sup>M</sup>

2SVA

ES-4 / ES-4VA

VOSSForm<sup>SQR</sup> /  
VOSSForm<sup>SQR</sup> VA

BV-10

DKO

ZAKO / ZAKO LP

Straight male  
stud couplings

Adjustable ISO 6149 /  
11926 couplings

Adjustable  
elbow couplings

37° flared adapters

Blanking screws

\* Nm = Recommended tightening torques for M8-M30 cylinder screws at friction coefficient  $\mu$  tot: 0.14

Tightening torques for straight male stud couplings



VOSS Ring<sup>M</sup>

2SVA

ES-4 / ES-4VA

VOSSForm<sup>SQR</sup> /  
VOSSForm<sup>SQR</sup> VA

BV-10

DKO

ZAKO / ZAKO LP

Straight male  
stud couplingsAdjustable ISO 6149 /  
11926 couplingsAdjustable  
elbow couplings

37° flared adapters

Blanking screws

Series	Inch-based male thread	Tightening torque sealing type DIN 3852 T 2 Form B / ISO 1179- 4 seal edge Nm -10 %	Tightening torque sealing type DIN 3852 T 11 Form E / ISO 1179-2 PEFLEX ring Nm -10 %	Metric male thread	Tightening torque sealing type DIN 3852 T 1 Form B / ISO 9974-3 seal edge Nm -10%	Tightening torque sealing type DIN 3852 T 11 Form E / ISO 9974-2 PEFLEX ring Nm -10%
L	G 1/8	25	20	M 10 x 1.0	25	15
L	G 1/4	55	50	M 12 x 1.5	35	25
L	G 3/8	95	80	M 14 x 1.5	55	50
L	G 1/2	185	100	M 16 x 1.5	80	70
L	G 3/4	250	180	M 18 x 1.5	100	90
L	G 1	400	230	M 22 x 1.5	170	130
L	G 1 1/4	670	330	M 26 x 1.5	230	180
L	G 1 1/2	800	500	M 33 x 2.0	400	230
				M 42 x 2.0	700	330
				M 48 x 2.0	900	500
S	G 1 / 4	95	60	M 12 x 1.5	60	50
S	G 3/8	180	90	M 14 x 1.5	90	60
S	G 1/2	160	150	M 16 x 1.5	120	80
S	G 3/4	350	200	M 18 x 1.5	190	90
S	G 1	700	250	M 22 x 1.5	300	130
S	G 1 1/4	850	500	M 27 x 2.0	420	200
S	G 1 1/2	1.000	600	M 33 x 2.0	600	250
				M 42 x 2.0	700	500
				M 48 x 2.0	900	600

Tightening torques for adjustable couplings as per ISO 6149 / 11926

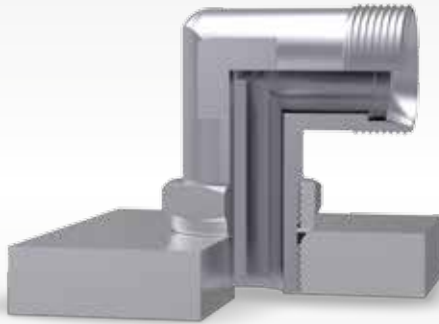



Important / General information

VOSS Ring<sup>M</sup>

2SVA

ES-4 / ES-4VA

VOSSForm<sup>SQR</sup> /  
VOSSForm<sup>SQR</sup> VA

BV-10

DKO

ZAKO / ZAKO LP

Straight male  
stud couplings

Adjustable ISO 6149 /  
11926 couplings

Adjustable  
elbow couplings

37° flared adapters

Blanking screws



Series	Thread	Tightening torque sealing type ISO 6149 Nm -10 %	Thread	Tightening torque sealing type ISO 11926 Nm -10 %
L	M 10 x 1	15	7/16 -20 UNF-2A	25
L	M 12 x 1.5	25	1/2 -20 UNF-2A	28
L	M 14 x 1.5	35	9/16 -18 UNF-2A	30
L	M 16 x 1.5	40	3/4 -16 UNF-2A	55
L	M 18 x 1.5	45	7/8 -14 UNF-2A	60
L	M 22 x 1.5	60	1 1/16 -12 UN-2A	110
L	M 27 x 2	100	1 3/16 -12 UN-2A	140
L	M 33 x 2	160	1 5/16 -12 UN-2A	165
L	M 42 x 2	210	1 5/8 -12 UN-2A	220
L	M 48 x 2	260	1 7/8 -12 UN-2A	260
S	M 12 x 1.5	35	7/16 -20 UNF-2A	30
S	M 14 x 1.5	45	1/2 -20 UNF-2A	45
S	M 16 x 1.5	55	9/16 -18 UNF-2A	75
S	M 18 x 1.5	70	3/4 -16 UNF-2A	100
S	M 22 x 1.5	100	7/8 -14 UNF-2A	160
S	M 27 x 2	170	1 1/16 -12 UN-2A	270
S	M 33 x 2	310	1 5/16 -12 UN-2A	270
S	M 42 x 2	330	1 5/8 -12 UN-2A	450
S	M 48 x 2	420	1 7/8 -12 UN-2A	520

Tightening torques for adjustable elbow couplings with lock nut

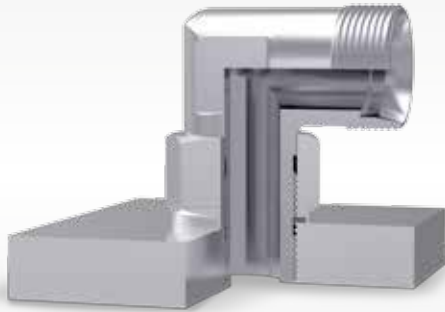

Important / General information

VOSS Ring<sup>M</sup>

2SVA

ES-4 / ES-4VA

VOSSForm<sup>SQR</sup> /  
VOSSForm<sup>SQR</sup> VA

BV-10

DKO

ZAKO / ZAKO LP

Straight male  
stud couplings

Adjustable ISO 6149 /  
11926 couplings

Adjustable  
elbow couplings

37° flared adapters

Blanking screws



Series	Inch-based threads	Tightening torque sealing type ISO 1179 Nm -10 %	Metric threads	Tightening torque sealing type DIN 3852 Nm -10 %
L	G 1/8	20	M 10 x 1	18
L	G 1/4	50	M 12 x 1.5	35
L	G 3/8	80	M 14 x 1.5	55
L	G 1/2	105	M 16 x 1.5	80
L	G 3/4	190	M 18 x 1.5	90
L	G 1	250	M 22 x 1.5	130
L	G 1 1/4	400	M 26 x 1.5	180
L	G1 1/2	500	M 27 x 2	190
L			M 33 x 2	250
L			M 42 x 2	350
L			M 48 x 2	500
S	G 1/4	50	M 12 x 1.5	35
S	G 3/8	80	M 14 x 1.5	55
S	G 1/2	110	M 16 x 1.5	80
S	G 3/4	220	M 18 x 1.5	90
S	G 1	280	M 22 x 1.5	130
S	G 1 1/4	400	M 27 x 2	220
S	G 1 1/2	500	M 33 x 2	250
S			M 42 x 2	350
S			M 48 x 2	500

Final assembly with tightening torque for 37° flared adapters

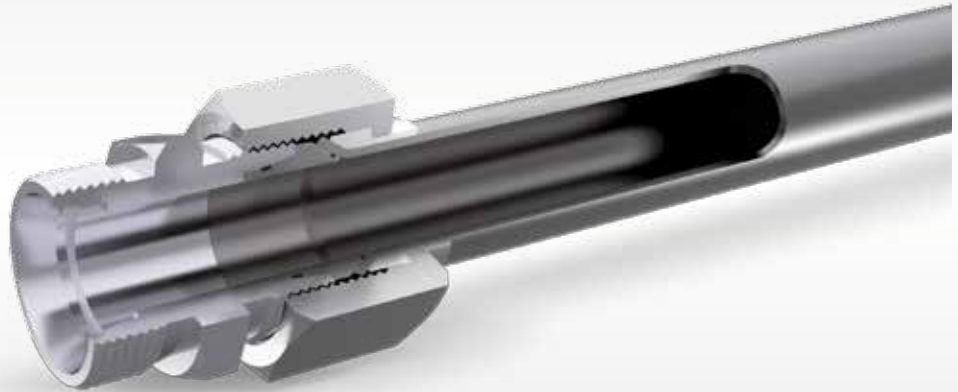

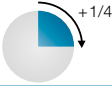
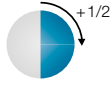
Series	Tube OD [mm]	Tightening torque steel tube Nm $\pm$ 5 %	Tightening torque stainless steel tube Nm $\pm$ 5 %	During the final assembly tighten union nut until a noticeable force increase.
L	6	20	30	
L	8	40	55	
L	10	45	65	
L	12	55	110	
L	15	70	190	
L	18	120	250	
L	22	200	400	
L	28	300	550	
L	35	600	900	
L	42	800	900	
S	6	30	85	
S	8	45	100	
S	10	55	130	
S	12	80	190	
S	14	90	260	
S	16	130	330	
S	20	250	350	
S	25	400	700	
S	30	500	900	
S	38	800	900	

As an alternative to distance-dependent final assembly, torque-dependent assembly is also possible. The tightening torques are recommended values.

## Final assembly

Tighten union nut hand-tight.

Tighten union nut with a wrench until a noticeable force increase.

Continue tightening by approximately 1/2 turns (for L6 – L12, only approx. 1/4 turns).

Important / General information

VOSS Ring<sup>M</sup>

2SVA

ES-4 / ES-4VA

VOSSForm<sup>SQR</sup> /  
VOSSForm<sup>SQR</sup> VA

BV-10

DKO

ZAKO / ZAKO LP

Straight male stud couplings

Adjustable ISO 6149 / 11926 couplings

Adjustable elbow couplings

37° flared adapters

Blanking screws

## Tightening torques for blanking screws



Thread	Form	Tightening torque Nm -10 %
M 8 x1	N	10
M 10 x1	N	12
M 10 x1	V	12
M 12 x1.5	N	23
M 14 x1.5	N	30
M 14 x1.5	V	30
M 16 x1.5	N	50
M 18 x1.5	N	65
M 18 x1.5	V	65
M 20 x1.5	N	75
M 22 x1.5	N	90
M 24 x1.5	N	90
M 26 x1.5	N	110
M 27 x2	N	130
M 33 x2	N	225
M 33 x2	V	250
M 42 x2	N	310
M 42 x2	V	400
M 48 x2	N	380
M 48 x2	V	500

Thread	Form	Tightening torque Nm -10 %
G 1/8	N	12
G 1/4	N	25
G 3/8	N	50
G 1/2	N	70
G 3/4	N	120
G 1	N	200
G 1	V	250
G 1 1/4	N	320
G 1 1/4	V	400
G 1 1/2	N	400
G 1 1/2	V	500

### Caution!

The recommended tightening torques concern steel fittings with VOSS coat surface coating and a steel mating material with a tensile strength  $\geq 350 \text{ N/mm}^2$ . For other strength, elasticity module and friction coupling values the tightening torques have to be empirically adapted by the user.

Important / General information

VOSS Ring<sup>M</sup>

2SVA

ES-4 / ES-4VA

VOSSForm<sup>SQR</sup> /  
VOSSForm<sup>SQR</sup> VA

BV-10

DKO

ZAKO / ZAKO LP

Straight male  
stud couplings

Adjustable ISO 6149 /  
11926 couplings

Adjustable  
elbow couplings

37° flared adapters

Blanking screws

# VOSS



VOSS Fluid GmbH  
P.O. Box 15 40  
51679 Wipperfürth, Germany

Lüdenscheider Straße 52–54  
51688 Wipperfürth  
Deutschland

Tel.: +49 2267 63-0  
Fax: +49 2267 63-5621

[fluid@voss.net](mailto:fluid@voss.net)  
[www.voss-fluid.net](http://www.voss-fluid.net)